

# Spacecraft Propellant Tanks

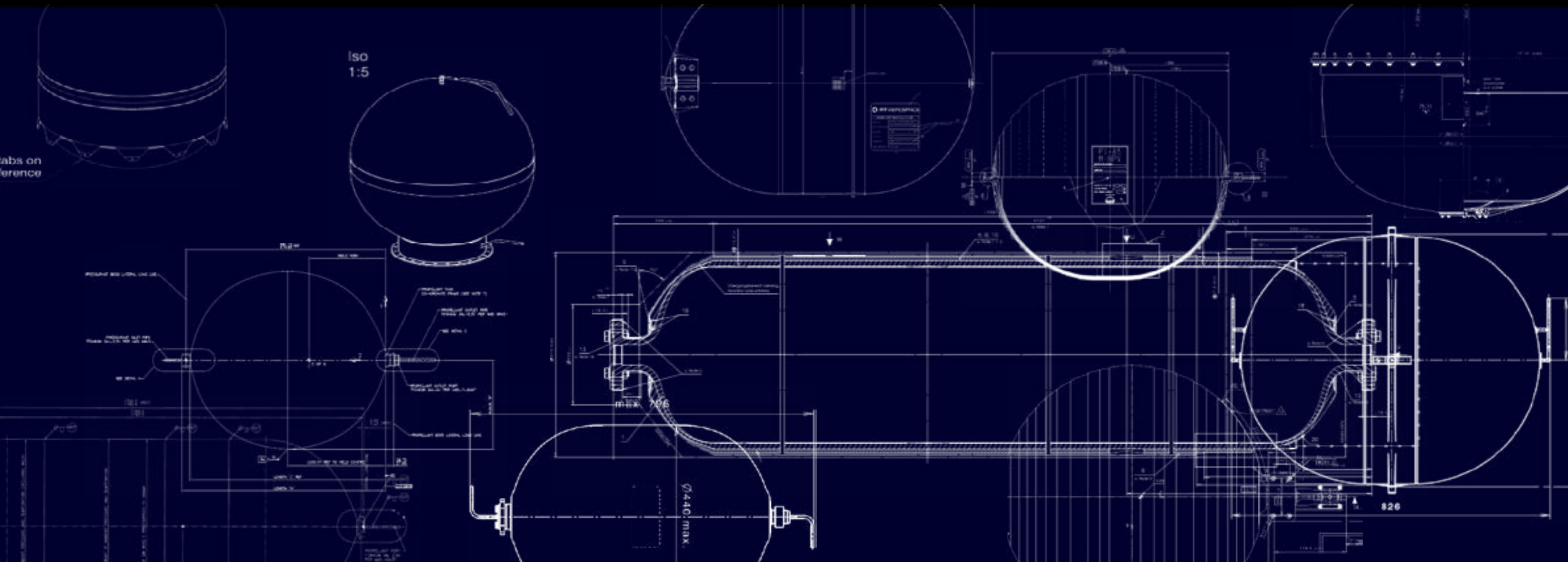

# Content

---

## TANKS IN SPACE / HERITAGE ..... 3

### DIAPHRAGM TANKS

177 litre PTD Hydrazine (N <sub>2</sub> H <sub>4</sub> ) .....	4
222 litre PTD Hydrazine (N <sub>2</sub> H <sub>4</sub> ).....	5
96 litre PTD Hydrazine (N <sub>2</sub> H <sub>4</sub> ).....	6

### PMD TANKS

166 litre PMD.....	7
--------------------	---

## HIGH PRESSURE VESSELS

### High Pressure Vessels (HPV)

#### Helium, Nitrogen & Xenon

60 litre S-XTA Xenon (Xe) .....	8
40 - 75 litre HeHPV Family (He).....	9
75 - 120 litre Helium Tank .....	10

### High Pressure Vessels (HPV)

#### for Electric Propulsion (EP) /

#### Xenon Tank Assembly (XTA)

1-7 litre XS-XTA Family.....	11
40-120 litre S-XTA Family .....	12
600-900 litre L-XTA Family 1 /	
Electra- & NeoSat Platforms.....	13

## ATV PROGRAM

### (Restart Activities Required)

296 litre Water Bladder Tank.....	14
-----------------------------------	----

## LIST OF ABBREVIATIONS..... 15

# TANKS IN SPACE - HERITAGE

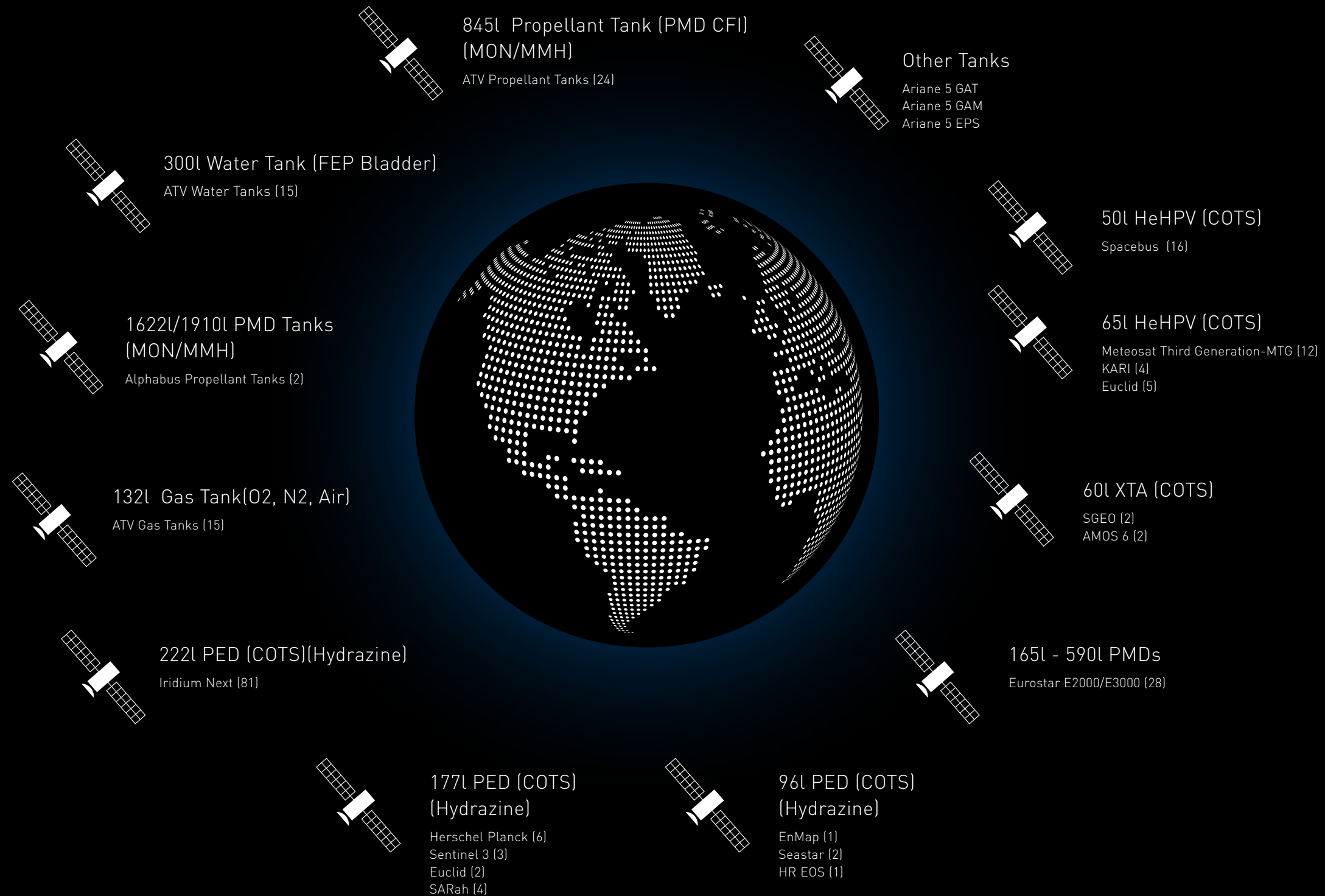

# PTD-177

## Monopropellant Diaphragm Tank – COTS



<b>HERITAGE</b>	Herschel Planck, Sentinel 3	
<b>FLUIDS</b>	N <sub>2</sub> H <sub>4</sub> (Hydrazine)	
<b>PRESSURANT GAS</b>	He, N <sub>2</sub>	
<b>PROPELLANT MANAGEMENT</b>	Diaphragm	
<b>MATERIALS</b>	Shell	Ti-6Al-4V
	Tube	Ti-3Al-2.5V
	Diaphragm	EPDM
<b>MOUNTING INTERFACE</b>	equatorial trunnions	
<b>TOTAL VOLUME</b>	177 l	10.801 in <sup>3</sup>
<b>PROPELLANT VOLUME</b>	135 l	8.238 in <sup>3</sup>
<b>TEMPERATURE RANGE</b>	0 / +50 °C	+32 / +122 °F
<b>TANK DRY MASS</b>	15,5 kg	34,2 lbs
<b>DIAMETER</b>	654,6 mm	25,77 in
<b>LENGTH</b>	827,0 mm	32,56 in
<b>MEOP*</b>	24,0 bar	348 psi
<b>PROOF PRESSURE (x 1,50)</b>	36,0 bar	522 psi
<b>BURST PRESSURE (x 2,00)</b>	48,0 bar	696 psi
<b>BURST PRESSURE TESTED</b>	55,5 bar	805 psi

\* Maximum Expected Operating Pressure

# PTD-222

## Monopropellant Diaphragm Tank – COTS

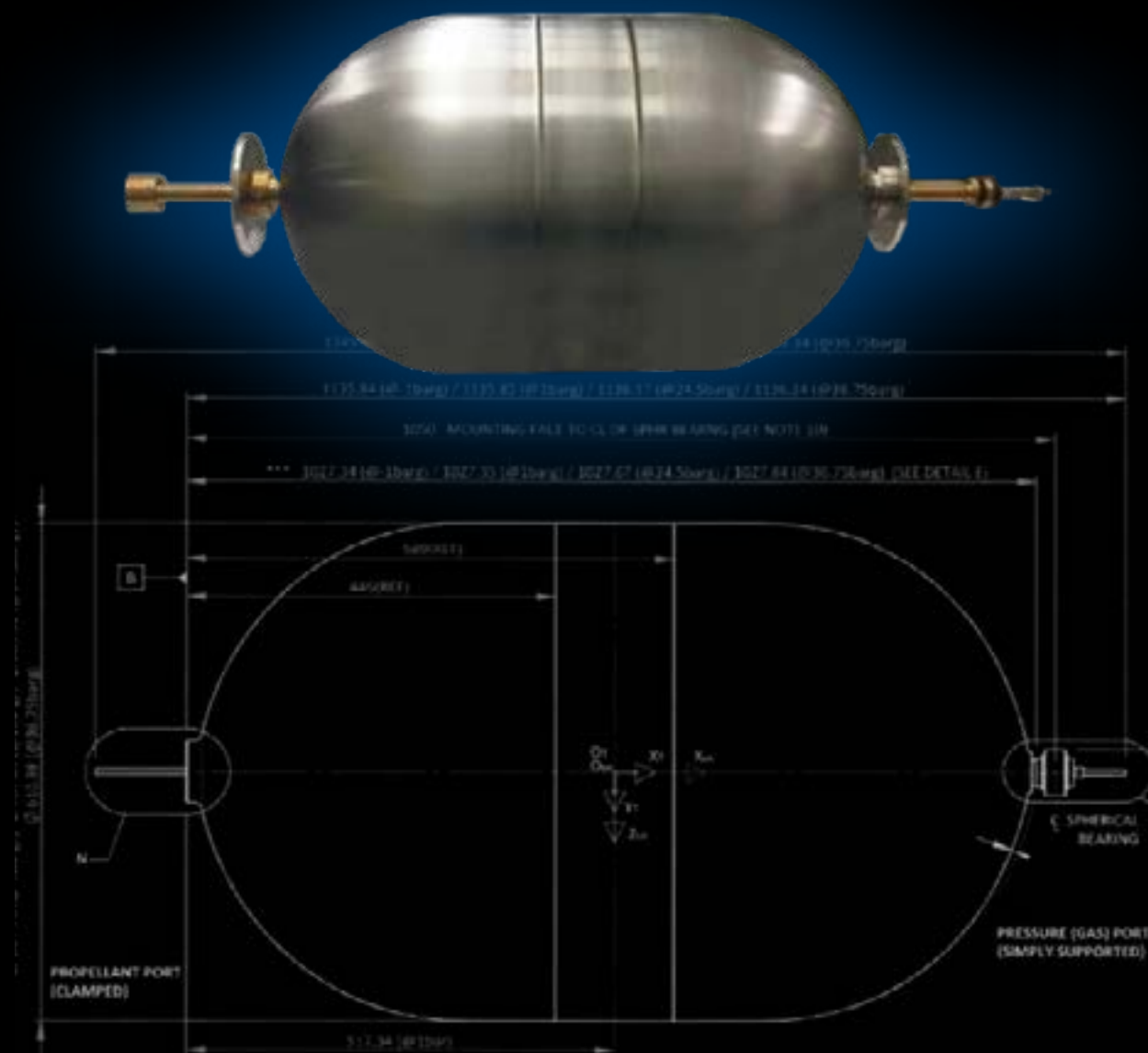

<b>HERITAGE</b>	Iridium NEXT	
<b>FLUIDS</b>	N <sub>2</sub> H <sub>4</sub> (Hydrazine)	
<b>PRESSURANT GAS</b>	He, N <sub>2</sub>	
<b>PROPELLANT MANAGEMENT</b>	Diaphragm	
<b>MATERIALS</b>	Shell	Ti-6Al-4V
	Tube	Ti-3Al-2.5V
	Diaphragm	EPDM
<b>MOUNTING INTERFACE</b>	polar	
<b>TOTAL VOLUME</b>	221,0 – 222,8 l	13.486 – 13.596 in <sup>3</sup>
<b>PROPELLANT MASS</b>	164 / 184 kg max	361,6 / 405,7 lbs
<b>TEMPERATURE RANGE</b>	+4 / +50 °C	+39,2 / +122 °F
<b>TANK DRY MASS</b>	17,08 ± 0,2 kg	37,6 ± 0,4 lbs
<b>DIAMETER</b>	607,75 ± 2 mm	23,93 ± 0,08 in
<b>LENGTH</b>	1.027,35 / 1.022,35 mm	40,45 / 40,25 in
<b>MEOP*</b>	24,5 bar	355 psi
<b>PROOF PRESSURE (x 1,50)</b>	36,8 bar	533 psi
<b>BURST PRESSURE (x 2,00)</b>	49,0 bar	711 psi
<b>RUPTURE PRESSURE TESTED</b>	bar	psi

\* Maximum Expected Operating Pressure

# PTD-96

## Monopropellant Diaphragm Tank – COTS with delta Qual

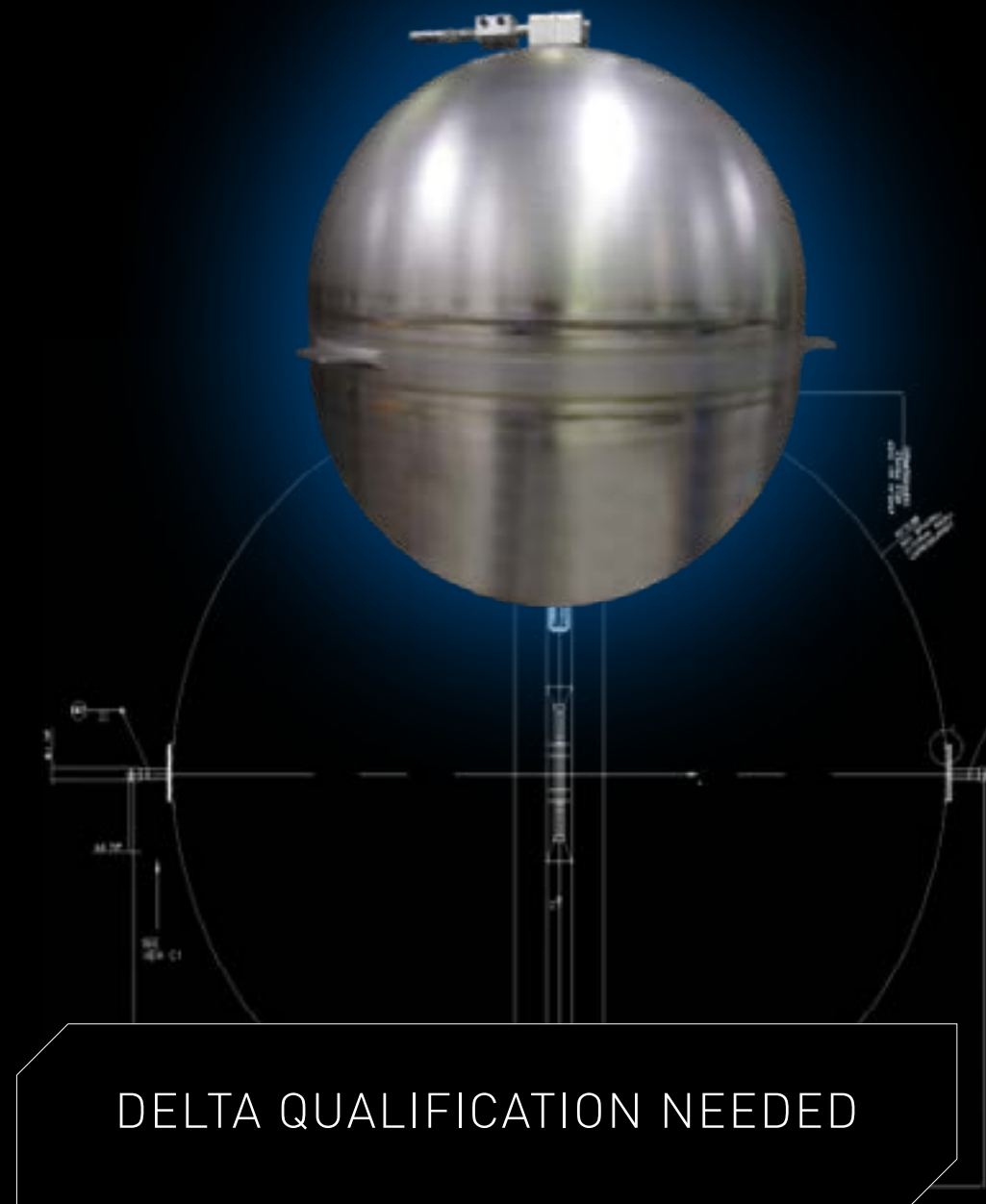

<b>HERITAGE</b>	Seastar, Goktürk, EnMap	
<b>FLUIDS</b>	N2H4 (Hydrazine)	
<b>PRESSURANT GAS</b>	He, N2	
<b>PROPELLANT MANAGEMENT</b>	Diaphragm; 4,5:1 blowdown	
<b>MATERIALS</b>	Shell	Ti-6Al-4V
	Tube	Ti-3Al-2.5V
	Diaphragm	EPDM
<b>MOUNTING INTERFACE</b>	equatorial mounting tabs	
<b>TOTAL VOLUME</b>	96 l	5.858 in <sup>3</sup>
<b>PROPELLANT MASS</b>	55 / 68 / 71 kg	121 / 150 / 157 lbs
<b>TEMPERATURE RANGE</b>	0 / +50 °C	+32 / +122 °F
<b>TANK DRY MASS</b>	8,2 kg	18,1 lbs
<b>DIAMETER</b>	545,0 mm	21,46 in
<b>LENGTH</b>	685,0 mm	26,97 in
<b>MEOP*</b>	24,0 bar	348 psi
<b>PROOF PRESSURE (x 1,50)</b>	36,0 bar	522 psi
<b>BURST PRESSURE (x 2,00)</b>	48,0 bar	696 psi
<b>RUPTURE PRESSURE TESTED</b>	72,1 bar	1046 psi

\* Maximum Expected Operating Pressure



# Eurostar Family PTP

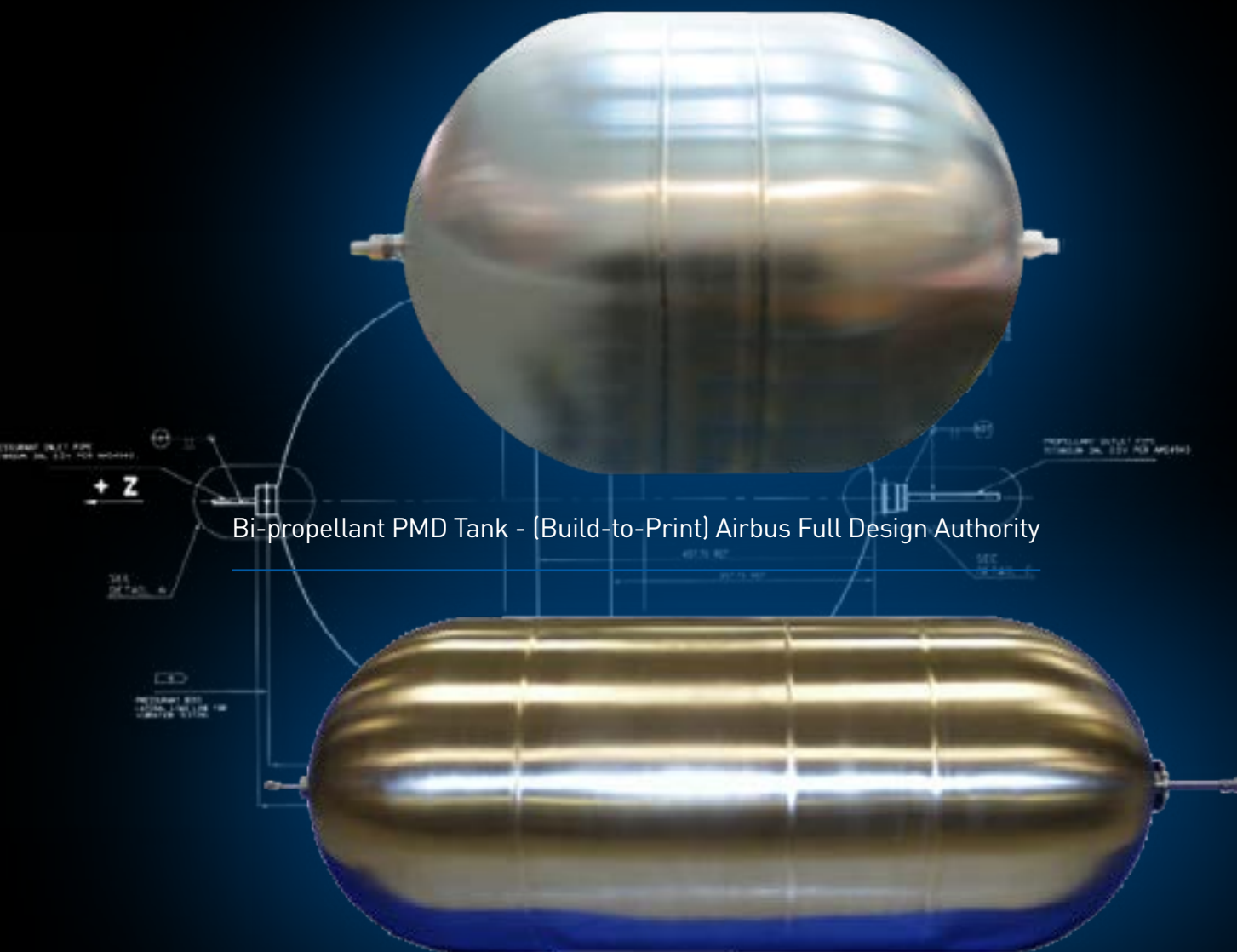

<b>HERITAGE</b>	GAIA, Eurostar 2000 & 3000	
<b>FLUIDS</b>	MMH, N <sub>2</sub> O <sub>4</sub>	
<b>PRESSURANT GAS</b>	He	
<b>PROPELLANT MANAGEMENT</b>	PMD	
<b>MATERIALS</b>	Shell	Ti-6Al-4V
	Tube	Ti-3Al-2.5V
	PMD	Ti-6Al-4V
<b>MOUNTING INTERFACE</b>	polar	
<b>TOTAL VOLUME</b>	165 l	10.069 in <sup>3</sup>
<b>TEMPERATURE RANGE</b>	0 / +50 °C	+32 / +122 °F
<b>TANK DRY MASS</b>	10,8 KG	23,8 LBS
<b>DIAMETER</b>	602,7 mm	23,73 in
<b>LENGTH</b>	856,0 mm	33,70 in
<b>MEOP*</b>	20,0 bar	290 psi
<b>PROOF PRESSURE (x 1,31)</b>	26,2 bar	380 psi
<b>BURST PRESSURE (x 1,50)</b>	30,0 bar	435 psi
<b>BURST PRESSURE TESTED (19°C)</b>	40,5 bar	587 psi

\* Maximum Expected Operating Pressure

# S-XTA-60

## Xenon Tank - COTS

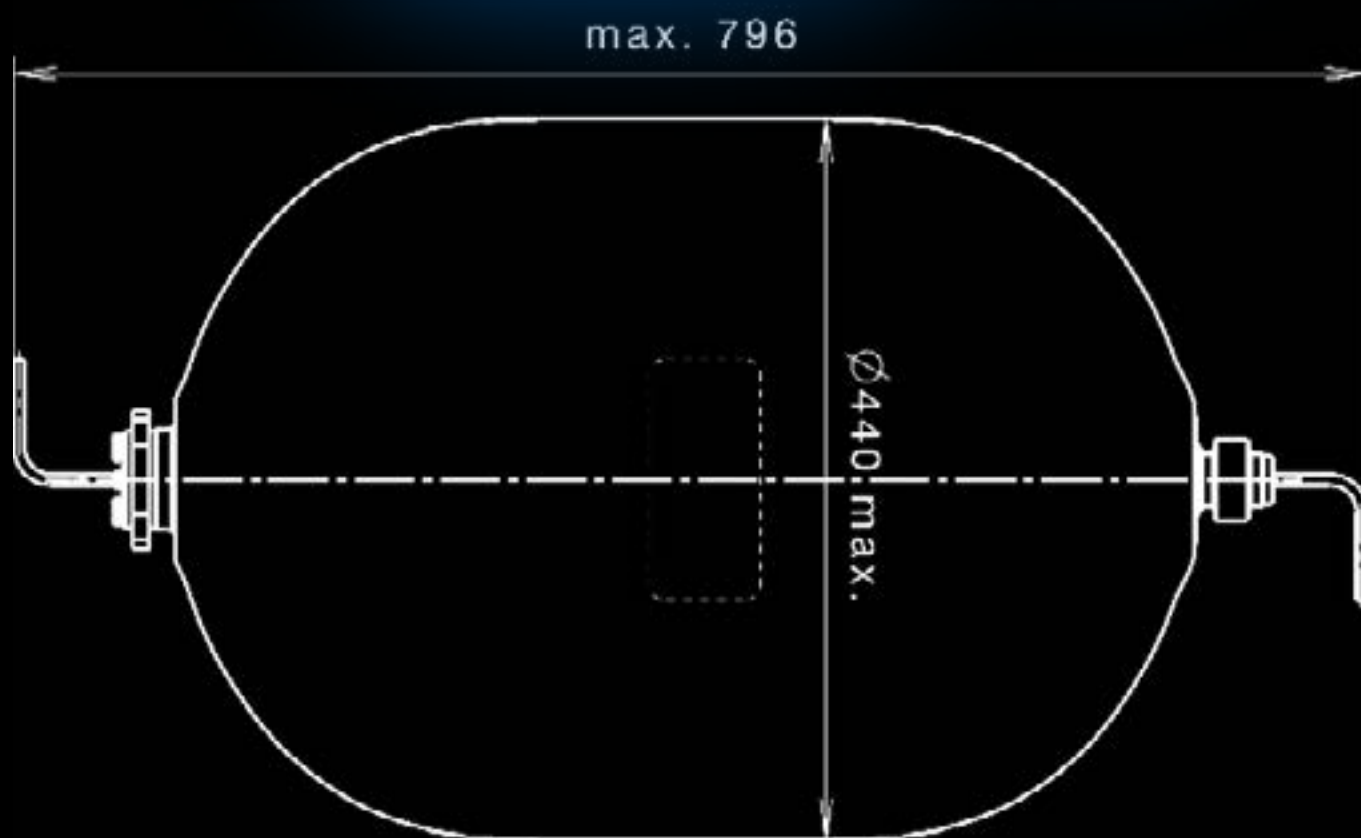
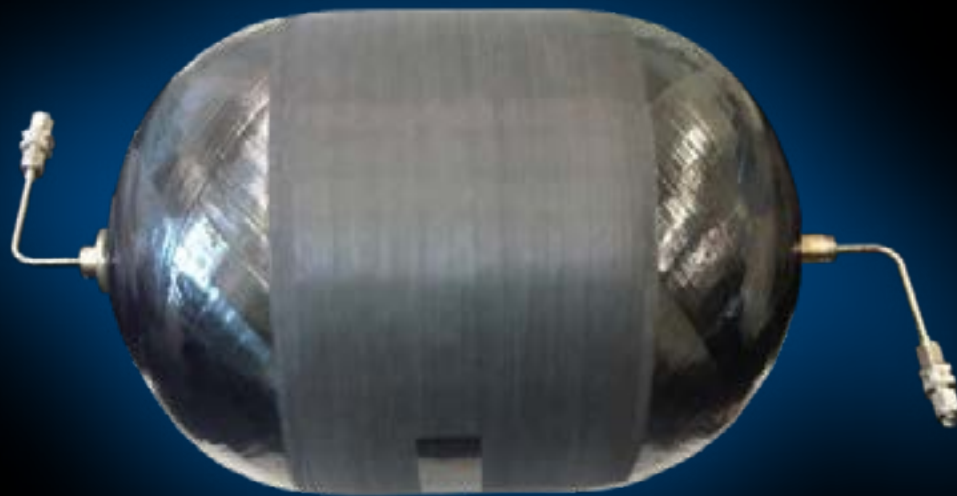

<b>HERITAGE</b>	SGEO, AMOS 6	
<b>FLUIDS</b>	<b>XENON</b>	
<b>MATERIALS</b>	Shell	Ti-6Al-4V
	Tube	Ti-3Al-2.5V
	Overwrapped	Epoxy-based CFRP / T800
<b>MOUNTING INTERFACE</b>	polar	
<b>TOTAL VOLUME</b>	60 l	3.661 in <sup>3</sup>
<b>TEMPERATURE RANGE</b>	up to 65 °C	up to 122 °F
<b>TANK DRY MASS</b>	11,7 kg	25,8 lbs
<b>DIAMETER</b>	440 mm	17,32 in
<b>LENGTH</b>	790,0 mm	31,10 in
<b>MEOP*</b>	187 bar	2.712 psi
<b>PROOF PRESSURE (x 1,25)</b>	233,8 bar	3.390 psi
<b>BURST PRESSURE (x 1,50)</b>	280,5 bar	4.068 psi
<b>BURST PRESSURE TESTED</b>	456,0 bar	6.614 psi

\* Maximum Expected Operating Pressure



# PVG Family 40 - 75 L

## High Pressure Tank (HPV) - Helium/Nitrogen - COTS



<b>HERITAGE</b>	SpaceBus, MTG, Euclid, KARI	
<b>FLUIDS</b>	Helium, Nitrogen	
<b>MATERIALS</b>	Shell	Ti-6Al-4V
	Tube	Ti-3Al-2.5V
	Overwrap	Epoxy-based CFRP / T800
<b>MOUNTING INTERFACE</b>	polar	
<b>TOTAL VOLUME</b> (unpressurized)	40 - 75 L	2380 - 4577 in <sup>3</sup>
<b>TEMPERATURE RANGE</b>	-30 / +60 °C	-22 / +140 °F
<b>TANK DRY MASS</b>	8,5 - 14,4 kg	18,7 - 31,7 lbs
<b>DIAMETER</b> (max. pressurized)	432,0 mm	17,01 in
<b>LENGTH</b> (max. pressurized)	467 - 728 mm	18,38 - 28,66 in
<b>MEOP*</b>	310,0 bar	4.496 psi
<b>PROOF PRESSURE</b> (x 1,25)	387,5 bar	5.620 psi
<b>BURST PRESSURE</b> (x 1,50)	465,0 bar	6.744 psi
<b>BURST PRESSURE TESTED</b>	633,0 bar	9.181 psi

\* Maximum Expected Operating Pressure

## PVG Family 80-120

### High Pressure Tank (HPV) – Helium/Nitrogen – COTS with delta Qual



<b>HERITAGE</b>	Extension of 40-75 litre HeHPV Family	
<b>FLUIDS</b>	Helium, Nitrogen	
<b>MATERIALS</b>	Shell	Ti-6Al-4V
	Tube	Ti-3Al-2.5V
	Overwrap	Epoxy-based CFRP / T800
<b>MOUNTING INTERFACE</b>	polar	
<b>TOTAL VOLUME</b> (unpressurized)	80-120 l	3.967 in <sup>3</sup>
<b>TEMPERATURE RANGE</b>	- 30 / +60 °C	-22 / +140°F
<b>TANK DRY MASS</b>	23,5 kg	51,81 lbs
<b>DIAMETER</b> (max. pressurized)	432,0 mm	17,01 in
<b>LENGTH</b> (max. pressurized)	? mm	? in
<b>MEOP*</b>	310,0 bar	4.496 psi
<b>PROOF PRESSURE</b> (x 1,25)	387,5 bar	5.620 psi
<b>BURST PRESSURE</b> (x 1,50)	465,0 bar	6.744 psi
<b>BURST PRESSURE TESTED</b>	633,0 bar	9.181 psi

\* Maximum Expected Operating Pressure

# XS-XTA / 1 - 7L Family

## Xenon Tank

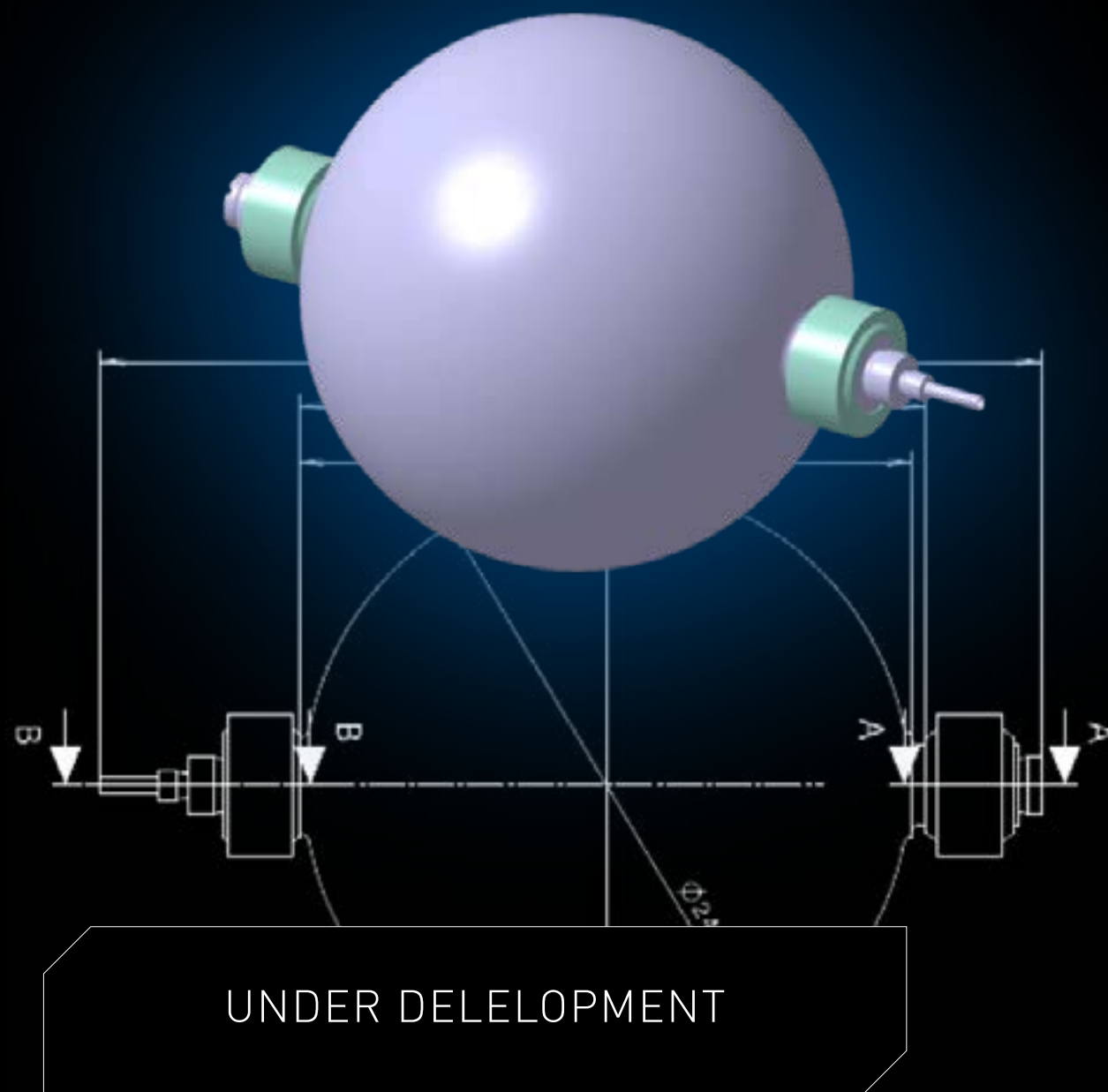

### HERITAGE

<b>FLUIDS</b>		Xenon
<b>MATERIALS</b>	Shell	Ti-6Al-4V
	Tube	Ti-3Al-2.5V
<b>MOUNTING INTERFACE</b>		polar

<b>TOTAL VOLUME</b>	1 - 7 l	61 - 427 in <sup>3</sup>
<b>TEMPERATURE RANGE</b>	up to 55 °C	up to 131 °F
<b>TANK DRY MASS</b>	≤3,5 kg	≤7,7 lbs
<b>DIAMETER</b>	242 mm	9,53 in
<b>LENGTH</b>	≤386 mm	≤15,20 in

<b>MEOP*</b>	bar	psi
<b>PROOF PRESSURE (x 1,5)</b>	bar	psi
<b>BURST PRESSURE (x 3,0)</b>	bar	psi
<b>BURST PRESSURE TESTED</b>	bar	psi

\* Maximum Expected Operating Pressure

# S-XTA / 40-120L Family

## Xenon Tank

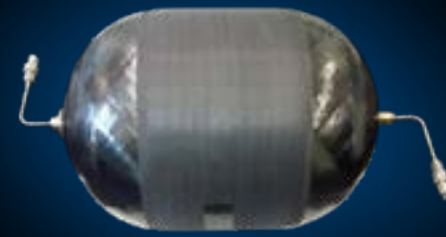

MEOP [bar]	XeHPV 186			HeHPV, N2HPV 310			
	HeHPV Liner <i>without boss area reinforcement</i>						
	Volume [l]	Structural Mass [kg]	Xe Mass [kg]	Volume [l]	Structural Mass [kg]	He Mass [kg]	N <sub>2</sub> Mass [kg]
	40	6.3	73	40	8.1	1.8	12.1
	60	8.9	110	65	12.4	2.9	19.6
	90	12.8	165	90	16.7	4.0	27.1
	120	16.8	220	120	21.8	5.3	36.2
Two Bearings	per §2.2	0.66		per §2.2	0.66		

XeHPV Tank Sizes  
 Di=405 mm, Do=418.4 mm  
 MEOP\*=186 bar

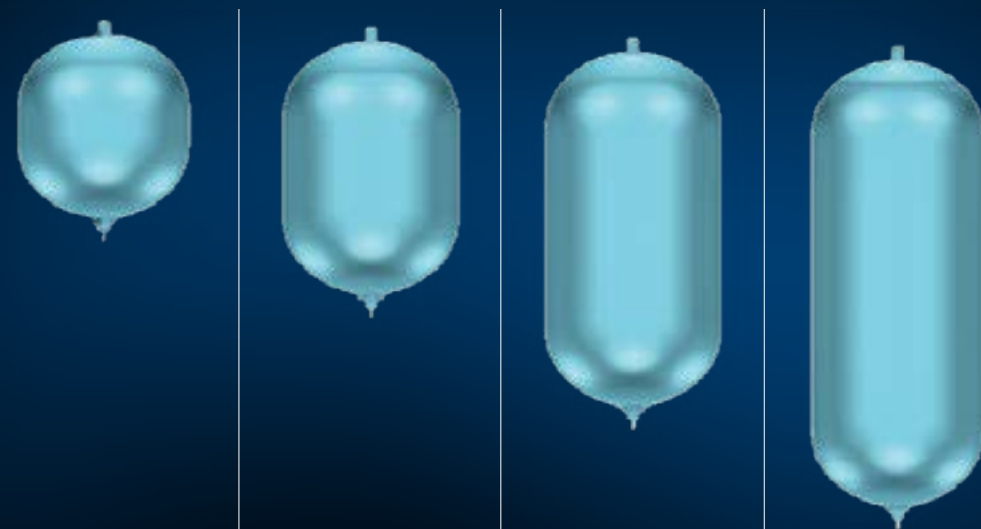

V=40 l	60 l	90 l	120 l
L=446 mm	601 mm	835 mm	1072 mm
m <sub>Struct_pred</sub> =6.3 kg	8,9 kg	12,8 kg	16,8 kg
M <sub>Xe_max</sub> =73 kg	110 kg	165 kg	220 kg

UNDER DEVELOPMENT

<b>HERITAGE</b>	Extension of 60 litre S-XTA	
<b>FLUIDS</b>	Xenon	
<b>MATERIALS</b>	Shell	Ti-6Al-4V
	Tube	Ti-3Al-2.5V
	Overwrapped	Epoxy-based CFRP / T800
<b>MOUNTING INTERFACE</b>	polar	

<b>TOTAL VOLUME</b>	40 - 120 l	2441-7323 in <sup>3</sup>
<b>TEMPERATURE RANGE</b>	up to 65 °C	up to 149 °F
<b>TANK DRY MASS</b>	6,3 - 14,8 kg	13,89 - 32,63 lbs
<b>DIAMETER</b>	440 mm	17,32 in
<b>LENGTH</b>	446 - 1072 mm	17,56 - 42,20 in

<b>MEOP*</b>	187 bar	2.712 psi
<b>PROOF PRESSURE (x 1,25)</b>	233,8 bar	3.390 psi
<b>BURST PRESSURE (x 1,50)</b>	280,5 bar	4.068 psi
<b>BURST PRESSURE TESTED</b>	456,0 bar	6.614 psi

\* Maximum Expected Operating Pressure



# L-XTA / 300-900 Family

## Xenon Tank - Electric Propulsion (EP)



Image credit: ESA 2012,  
© OHB System AG



Image credit: ESA 2015  
© Thales Alenia Space

FOR ELECTRA & NEOSAT/  
SPACEBUS-NEO PLATFORMS

<b>HERITAGE</b>	under Qualification	
<b>FLUIDS</b>	Xenon	
<b>MATERIALS</b>	Shell	Ti-6Al-4V
	Tube	Ti-3Al-2.5V
	Overwrapped	Epoxy-based CFRP / T800
<b>MOUNTING INTERFACE</b>	equatorial skirt	
<b>TOTAL VOLUME</b>	600 - 900 l	36.614 - 54.921 in <sup>3</sup>
<b>TEMPERATURE RANGE</b>	up to 50 °C	up to 122 °F
<b>TANK DRY MASS</b>	68 - 85 kg	149,9 - 187,4 lbs
<b>DIAMETER</b>	1.144 mm	45,04 in
<b>LENGTH</b>	979,3 - 1306 mm	38,56 - 51,42 in
<b>MEOP*</b>	187 bar	2.712 psi
<b>PROOF PRESSURE (x 1,25)</b>	233,8 bar	3.390 psi
<b>BURST PRESSURE (x 1,50)</b>	280,5 bar	4.068 psi
<b>BURST PRESSURE TESTED</b>	bar	psi

\* Maximum Expected Operating Pressure



# WTB-296

## Potable Water Bladder Tank - (Re-start Activity required)



<b>HERITAGE</b>	ATV	
<b>FLUIDS</b>	Water	
<b>PRESSURANT GAS</b>	Air, N <sub>2</sub>	
<b>PROPELLANT MANAGEMENT</b>	Bladder	
<b>MATERIALS</b>	Shell	Stainless Steel
	Tube	
	Bladder	FEP
	Overwrap	Epoxy-based CFRP / T800
<b>MOUNTING INTERFACE</b>	equatorial	
<b>TOTAL VOLUME</b>	296 l	18.063 in <sup>3</sup>
<b>FLUID VOLUME</b>	280 l	17.087 in <sup>3</sup>
<b>TEMPERATURE RANGE</b>	+5 / +50 °C	+41 / +122 °F
<b>TANK DRY MASS</b>	28,5 kg	62,8 lbs
<b>DIAMETER</b>	916,0 mm	36,06 in
<b>LENGTH</b>	750,0 mm	29,53 in
<b>MEOP*</b>	4,0 bar	58 psi
<b>PROOF PRESSURE (x 1,50)</b>	6,0 bar	87 psi
<b>BURST PRESSURE (x 2,00)</b>	8,0 bar	116 psi
<b>BURST PRESSURE TESTED</b>	min. 14,0 bar	min. 203 psi

\* Maximum Expected Operating Pressure

## List of Abbreviations

---

<b>ABBREVIATION</b>	<b>DESCRIPTION</b>
AA	Aluminium Association
ATV	Automated Transfer Vehicle
CFRP	Carbon Fibre Reinforced Plastic
COTS	Commercial Off The Shelf
EP	Electric Propulsion
EPDM	Ethylene Propylene Diene Monomer
FEP	Fluorinated Ethylene Propylene
GRD	Gas Retention Device
GTA	Gas Tank Assembly
HPV	High Pressure Vessel
HeHPV	Helium High-Pressure Vessel
MEOP	Maximum Expected Operating Pressure
MMH	Mono Methyl Hydrazine
MON	Mixed Oxides of Nitrogen
N <sub>2</sub> HPV	Nitrogen High-Pressure Vessel
NTO	Nitrogen Tetroxide
PED	Positive Expulsion Device
PMD	Propellant Management Device
PTD	Propellant Tank Diaphragm
XTA	Xenon Tank Assembly